

# Calix<sup>®</sup>

Cervical Interbody Spacer

# Calix•ATP<sup>™</sup>

Peek Lumbar System



# Calix<sup>®</sup>

## Cervical Interbody Spacer

Large grafting area

Tantalum markers

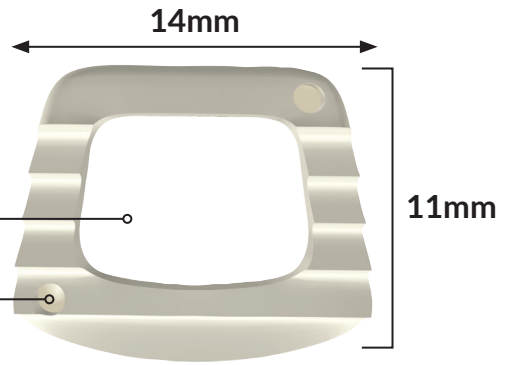

Available in sizes from 5mm to 12mm

Three point instrument fixation  
precision instrument/implant interface

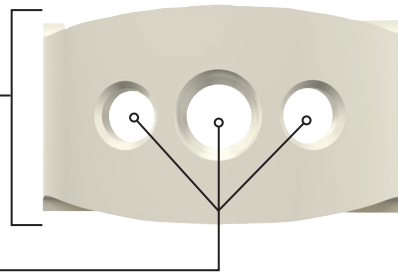

Migration resistant tooth profile

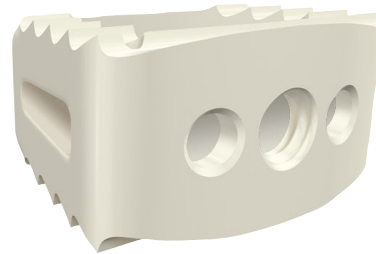
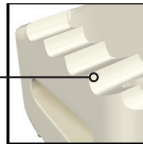

Convex



Lordotic

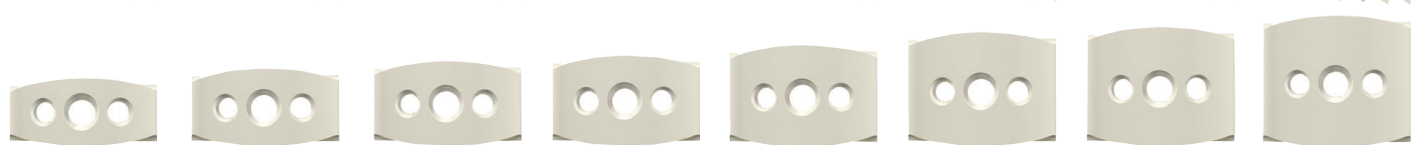

● 5mm

● 6mm

● 7mm

● 8mm

● 9mm

● 10mm

● 11mm

● 12mm

# Calix·A™

Peek Lumbar System

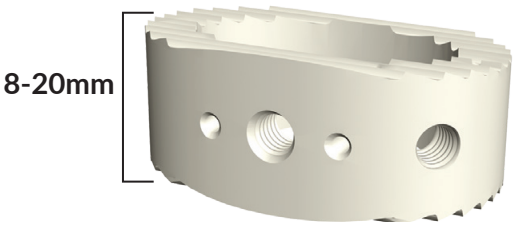
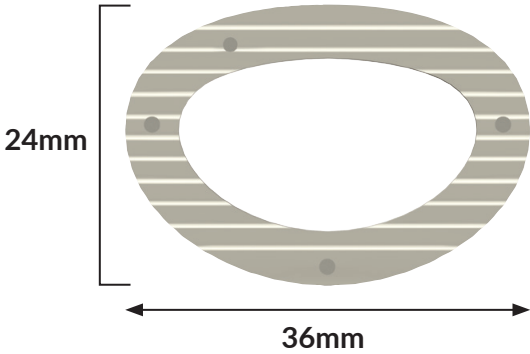
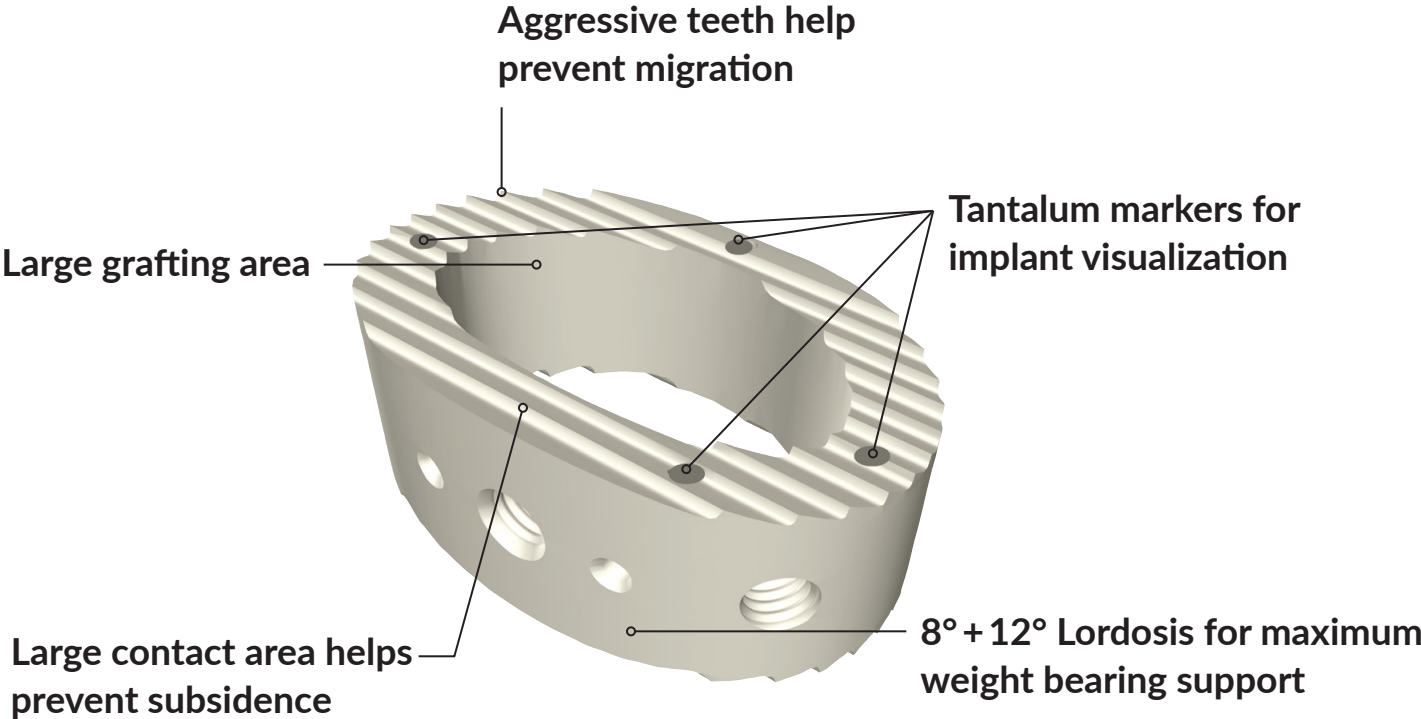

# Calix•T™

Peek Lumbar System

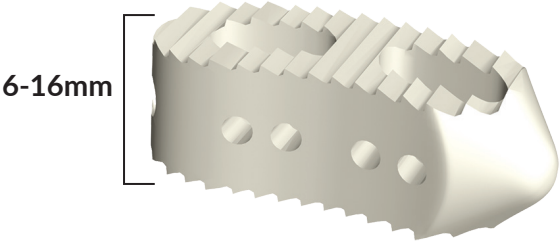
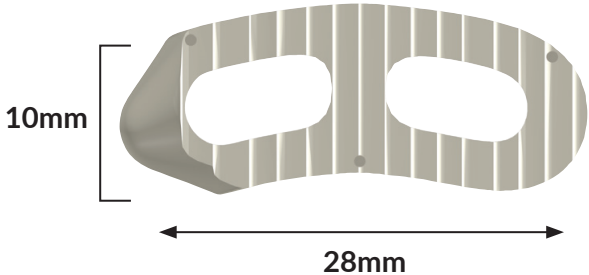
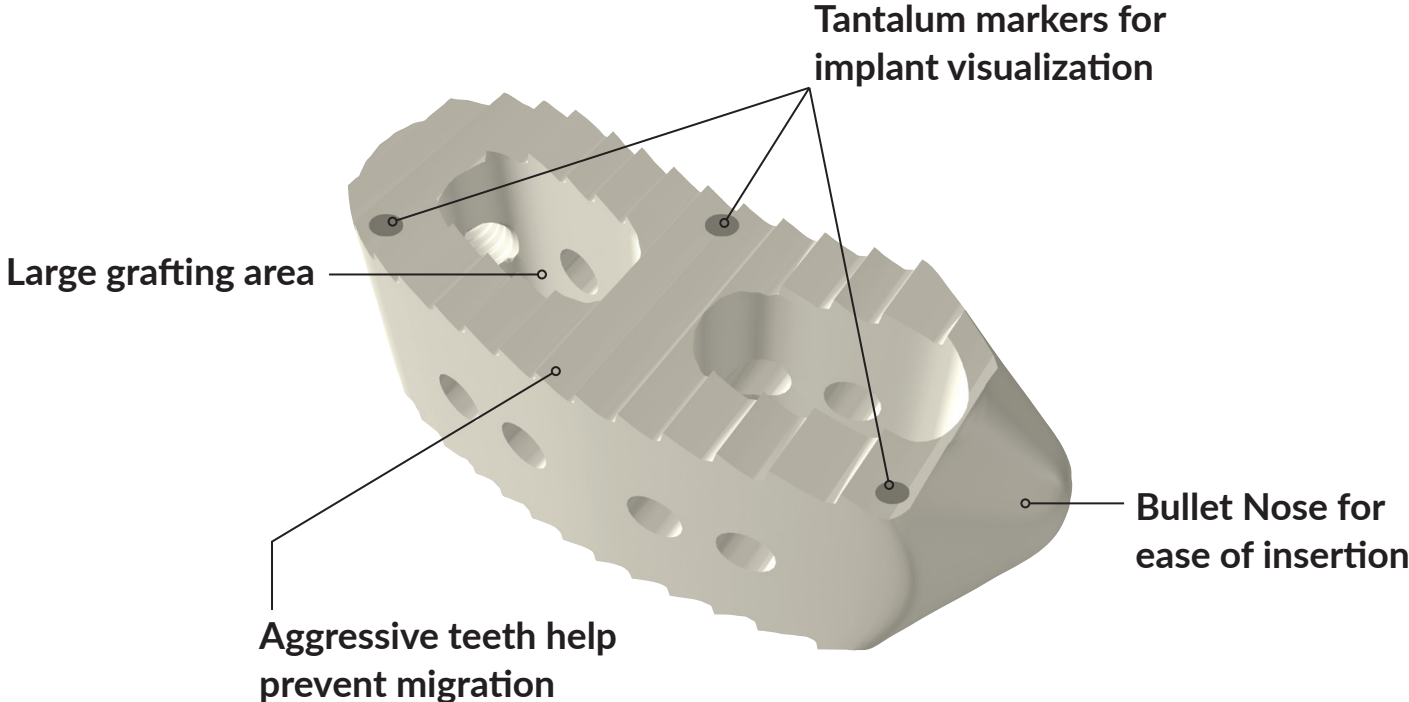

# Calix·P™

Peek Lumbar System

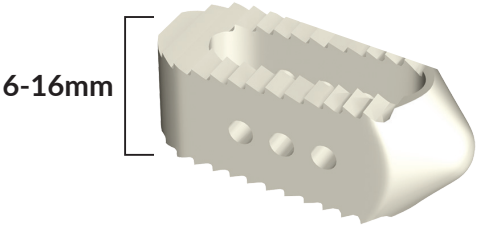
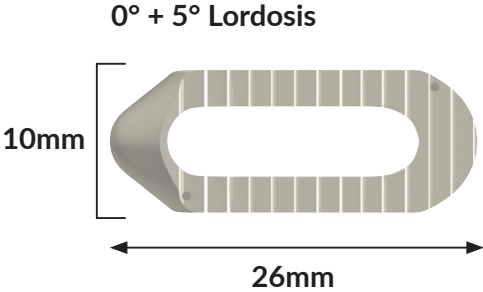
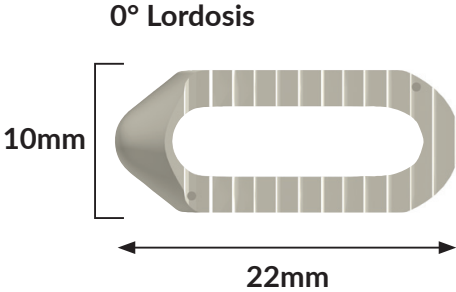
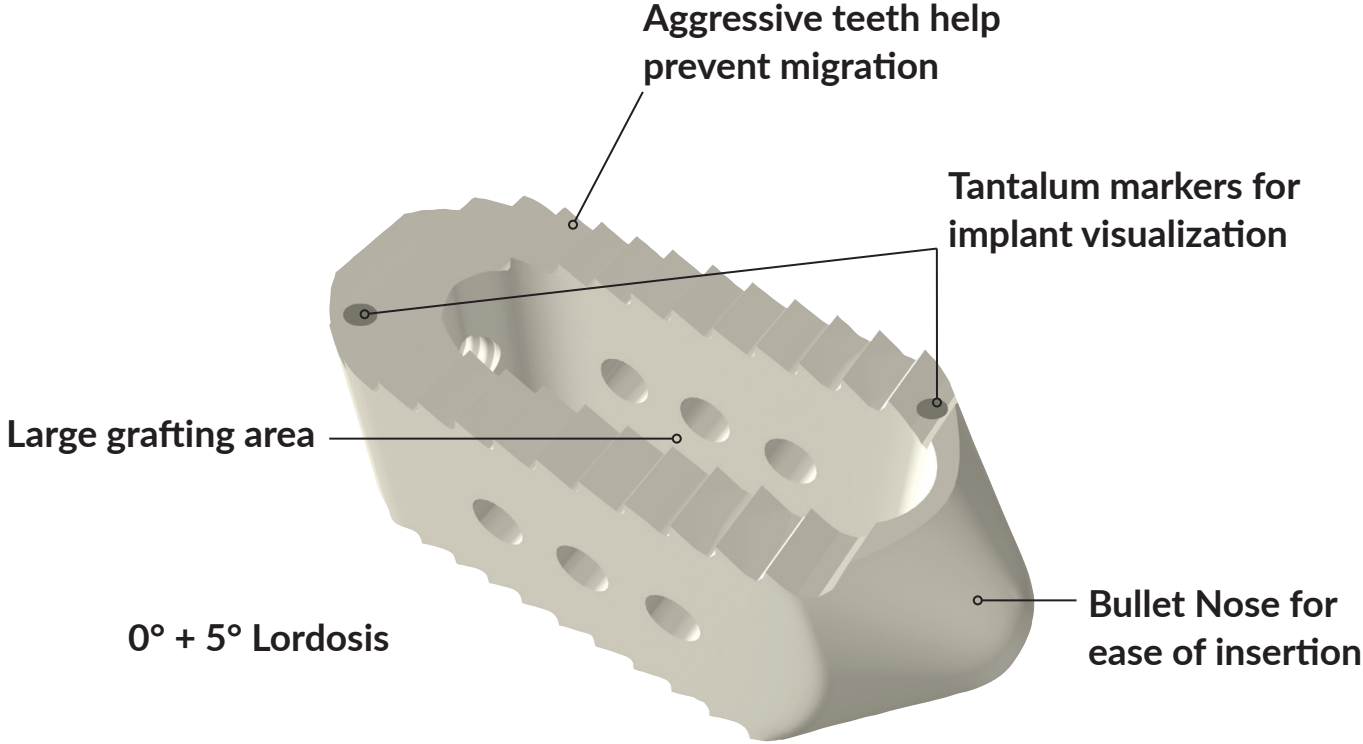

# Calix<sup>®</sup>

## Cervical Interbody Spacer

Item Number	Description
X003-0005	11mm x 14mm x 5mm x 7°, Lordotic
X003-0006	11mm x 14mm x 6mm x 7°, Lordotic
X003-0007	11mm x 14mm x 7mm x 7°, Lordotic
X003-0008	11mm x 14mm x 8mm x 7°, Lordotic
X003-0009	11mm x 14mm x 9mm x 7°, Lordotic
X003-0010	11mm x 14mm x 10mm x 7°, Lordotic
X003-0011	11mm x 14mm x 11mm x 7°, Lordotic
X003-0012	11mm x 14mm x 12mm x 7°, Lordotic
X003-0105	11mm x 14mm x 5mm Convex
X003-0106	11mm x 14mm x 6mm Convex
X003-0107	11mm x 14mm x 7mm Convex
X003-0108	11mm x 14mm x 8mm Convex
X003-0109	11mm x 14mm x 9mm Convex
X003-0110	11mm x 14mm x 10mm Convex
X003-0111	11mm x 14mm x 11mm Convex
X003-0112	11mm x 14mm x 12mm Convex

# Calix•A<sup>™</sup>

## Peek Lumbar System

Item Number	Description
X034-0320	36mm x 24mm x 8mm x 8°
X034-0321	36mm x 24mm x 10mm x 8°
X034-0322	36mm x 24mm x 12mm x 8°
X034-0323	36mm x 24mm x 14mm x 8°
X034-0324	36mm x 24mm x 16mm x 8°
X034-0325	36mm x 24mm x 18mm x 8°
X034-0326	36mm x 24mm x 20mm x 8°
X034-0330	36mm x 24mm x 8mm x 12°
X034-0331	36mm x 24mm x 10mm x 12°
X034-0332	36mm x 24mm x 12mm x 12°
X034-0333	36mm x 24mm x 14mm x 12°
X034-0334	36mm x 24mm x 16mm x 12°
X034-0335	36mm x 24mm x 18mm x 12°
X034-0336	36mm x 24mm x 20mm x 12°

# Calix•T<sup>™</sup>

## Peek Lumbar System

Item Number	Description
X034-0280	28mm x 10mm x 6mm
X034-0281	28mm x 10mm x 7mm
X034-0282	28mm x 10mm x 8mm
X034-0283	28mm x 10mm x 9mm
X034-0284	28mm x 10mm x 10mm
X034-0285	28mm x 10mm x 11mm
X034-0286	28mm x 10mm x 12mm
X034-0287	28mm x 10mm x 13mm
X034-0288	28mm x 10mm x 14mm
X034-0289	28mm x 10mm x 15mm
X034-0290	28mm x 10mm x 16mm

# Calix•P<sup>™</sup>

## Peek Lumbar System

Item Number	Description
X034-0171	22mm x 10mm x 6mm
X034-0172	22mm x 10mm x 7mm
X034-0173	22mm x 10mm x 8mm
X034-0174	22mm x 10mm x 9mm
X034-0175	22mm x 10mm x 10mm
X034-0176	22mm x 10mm x 11mm
X034-0177	22mm x 10mm x 12mm
X034-0178	22mm x 10mm x 13mm
X034-0179	22mm x 10mm x 14mm
X034-0180	22mm x 10mm x 15mm
X034-0181	22mm x 10mm x 16mm
X034-0240	26mm x 10mm x 6mm
X034-0245	26mm x 10mm x 7mm
X034-0241	26mm x 10mm x 8mm
X034-0246	26mm x 10mm x 9mm
X034-0242	26mm x 10mm x 10mm
X034-0247	26mm x 10mm x 11mm
X034-0243	26mm x 10mm x 12mm
X034-0248	26mm x 10mm x 13mm
X034-0244	26mm x 10mm x 14mm
X034-0249	26mm x 10mm x 15mm
X034-0387	26mm x 10mm x 6mm x 5°
X034-0388	26mm x 10mm x 7mm x 5°
X034-0389	26mm x 10mm x 8mm x 5°
X034-0390	26mm x 10mm x 9mm x 5°
X034-0391	26mm x 10mm x 10mm x 5°
X034-0392	26mm x 10mm x 11mm x 5°
X034-0393	26mm x 10mm x 12mm x 5°
X034-0394	26mm x 10mm x 13mm x 5°
X034-0395	26mm x 10mm x 14mm x 5°
X034-0396	26mm x 10mm x 15mm x 5°



[888.886.9354](tel:888.886.9354)  
[cs@xtantmedical.com](mailto:cs@xtantmedical.com)  
[xtantmedical.com](http://xtantmedical.com)

INDICATIONS: See Package Insert for a more complete listing of indications, contraindications, warnings, precautions, and other important information.

LIMITED WARRANTY and DISCLAIMER: Xtant Medical products have a limited warranty against defects and workmanship and materials. Any other express or implied warranties, including warranties of merchantability or fitness, are disclaimed. WARNING: In the USA, this product has labeling limitations. See package insert for complete information. CAUTION: USA Law restricts these devices to sale by or on the order of a physician.

Calix<sup>™</sup> is a trademark of Xtant Medical.

© Xtant Medical. All Rights Reserved. FM-C-MRK-55 Rev B 12/21